

Capítulo 23 (Lift) elevar

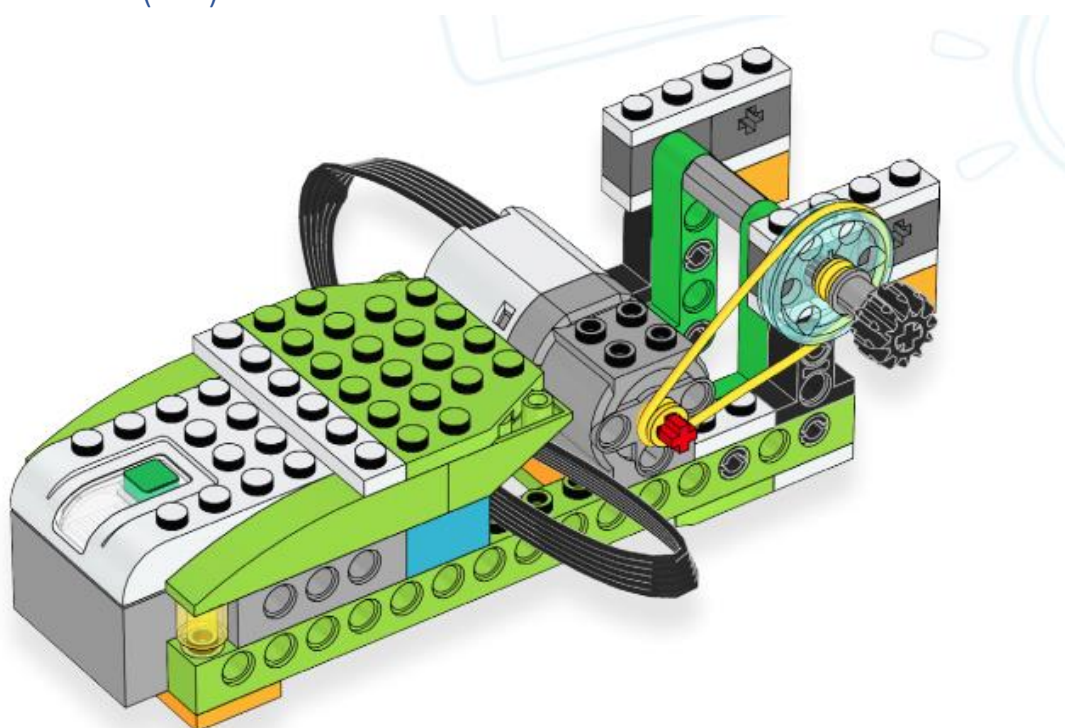

Para este capítulo necesitamos un solo Kit.

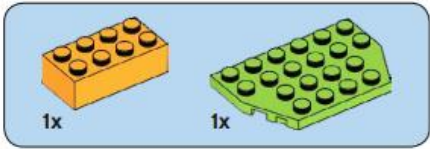

1

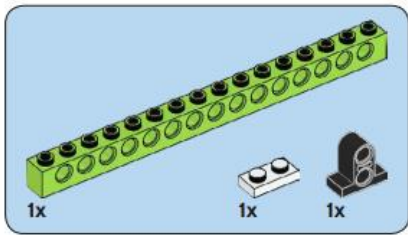
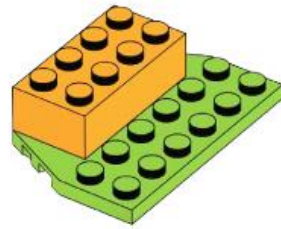

2

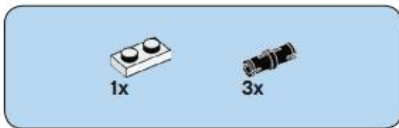
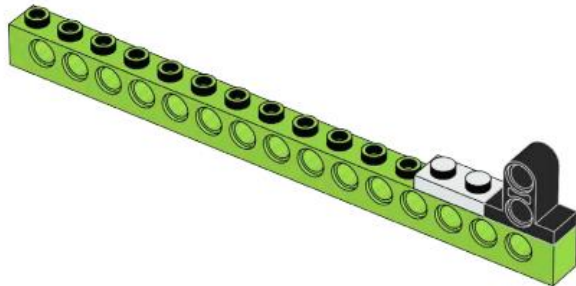

3

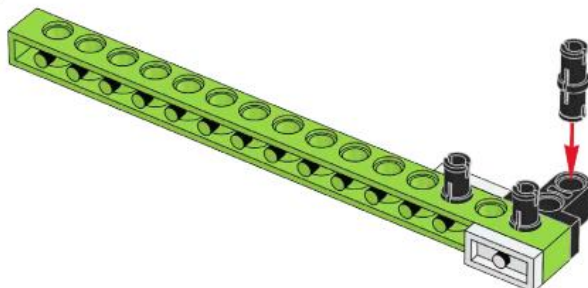

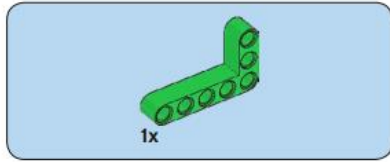

4

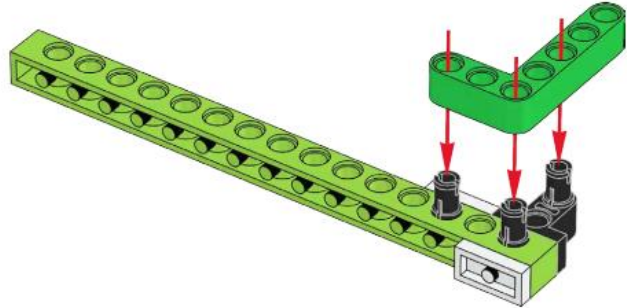

5

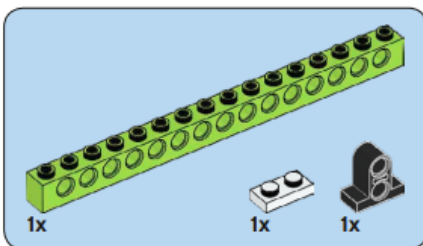
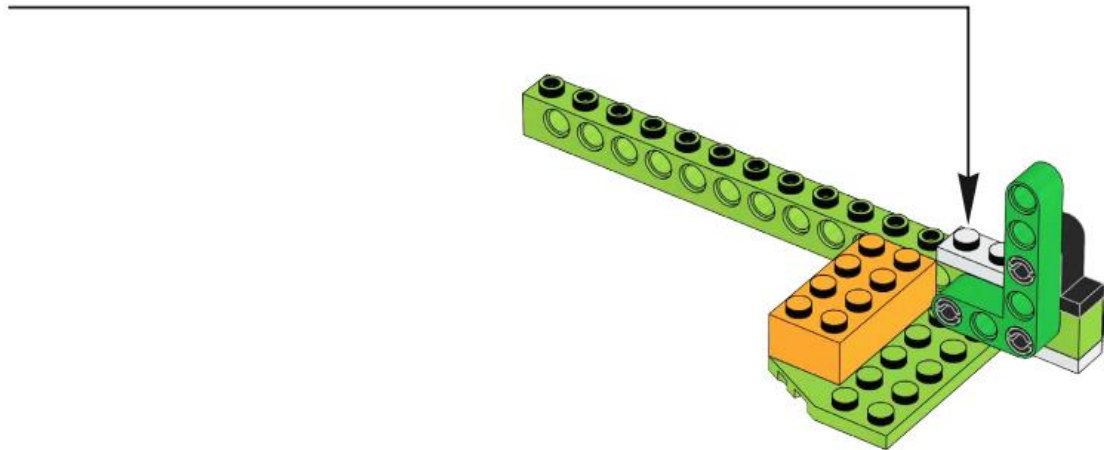

6

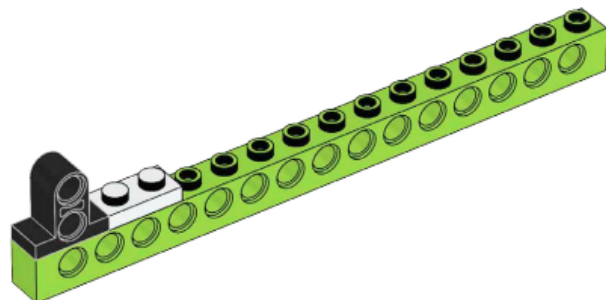

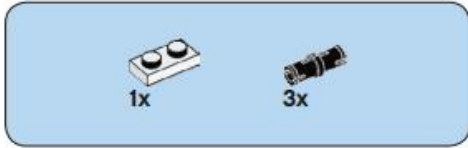

7

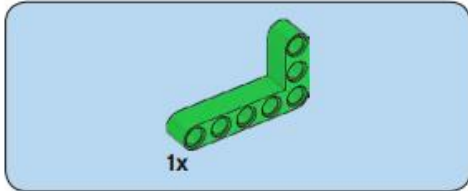
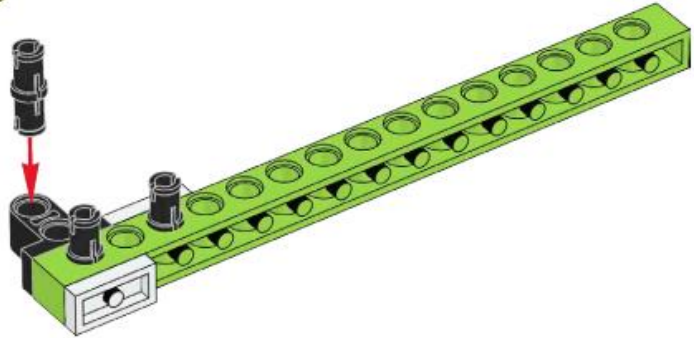

8

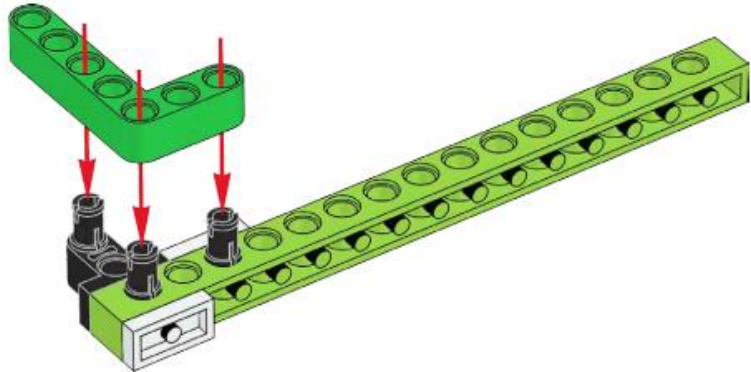

9

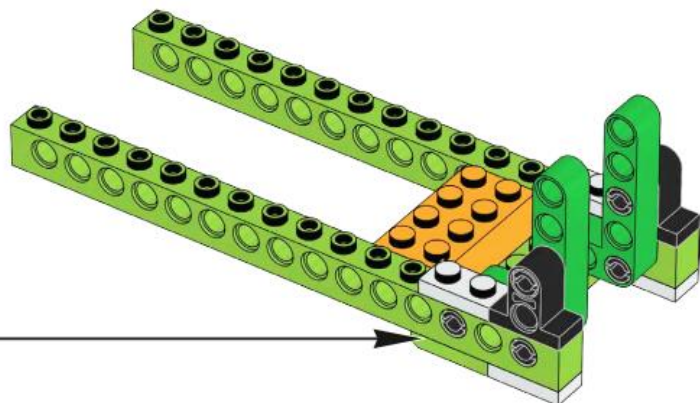

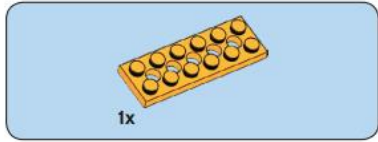

10

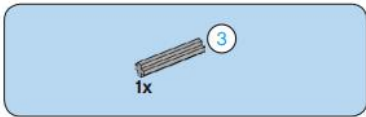
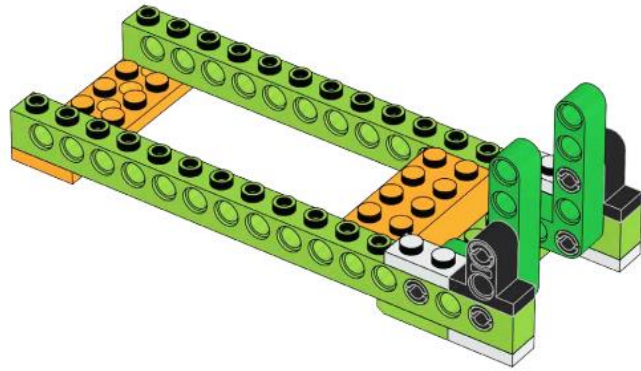

11

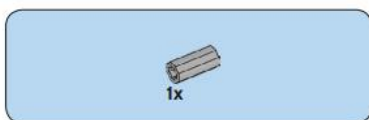
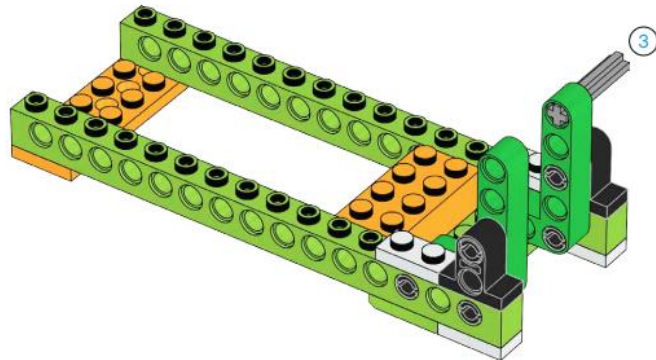

12

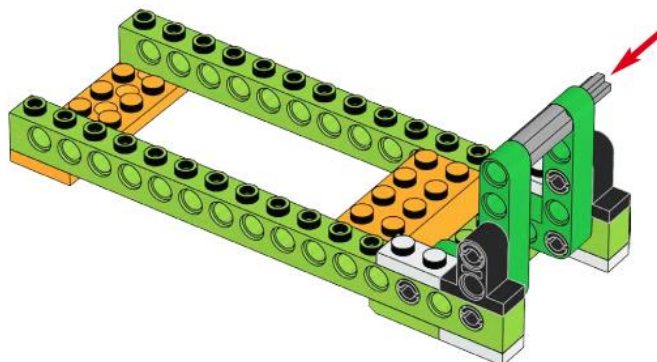

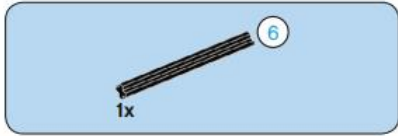

13

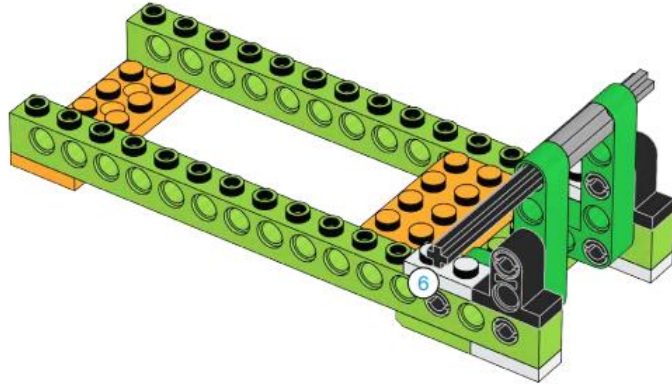

14

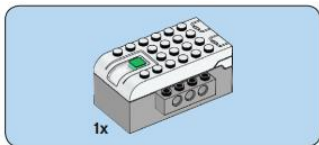
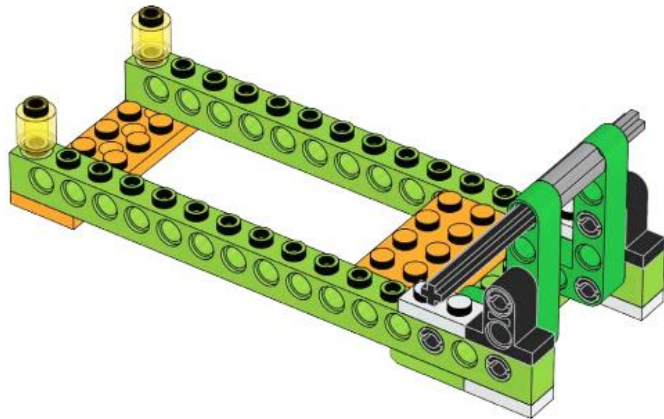

15

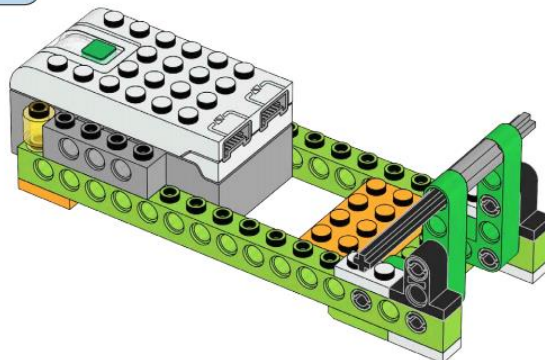

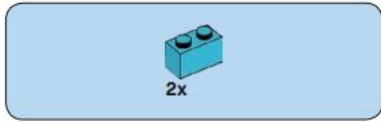

16

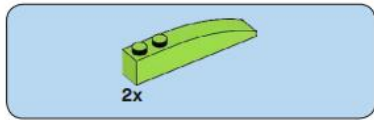
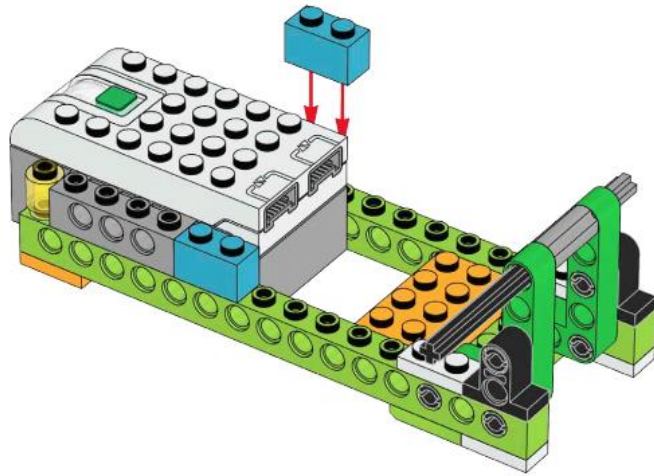

17

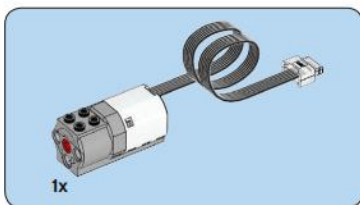
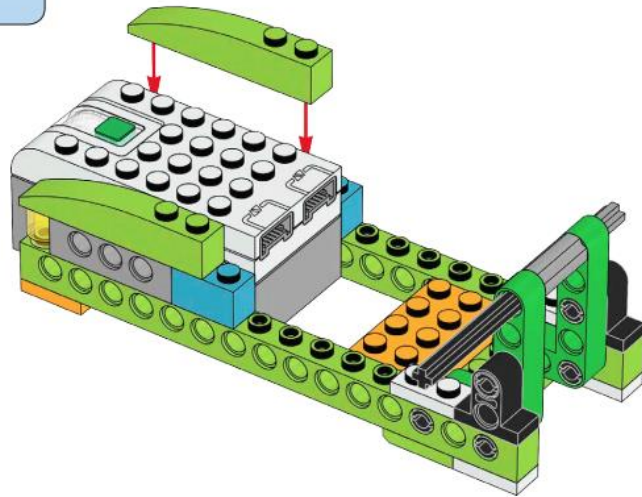

18

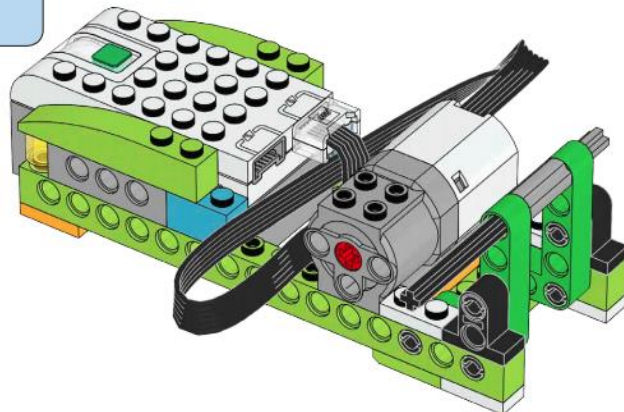

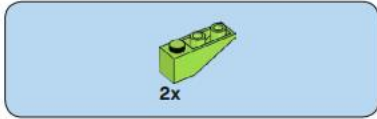

19

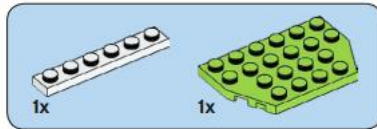
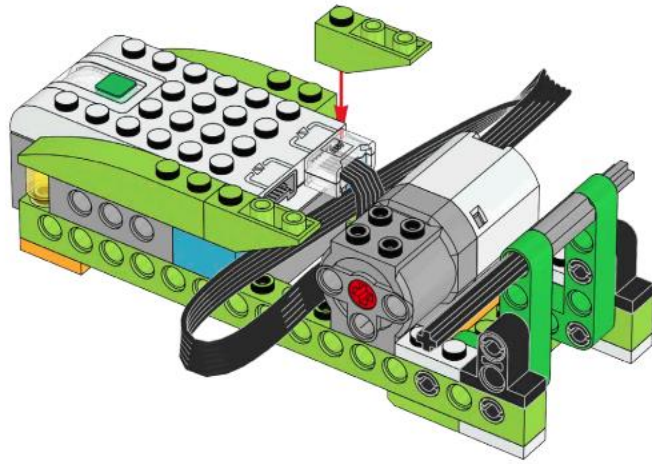

20

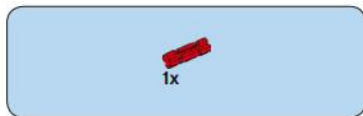
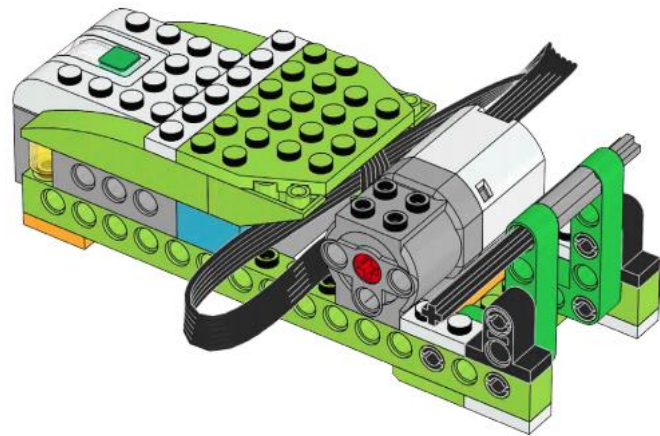

21

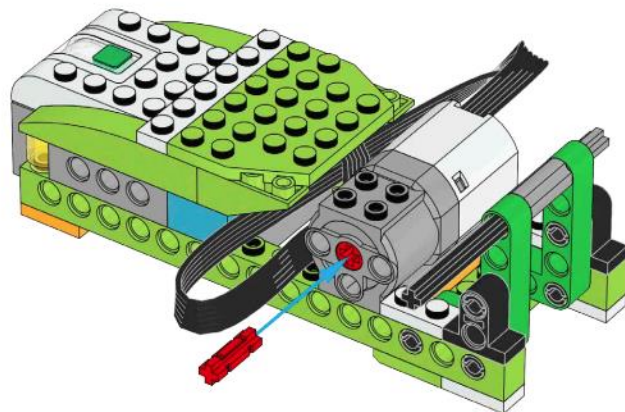



22

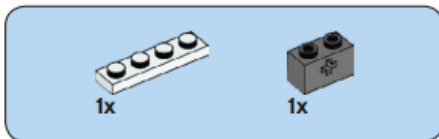
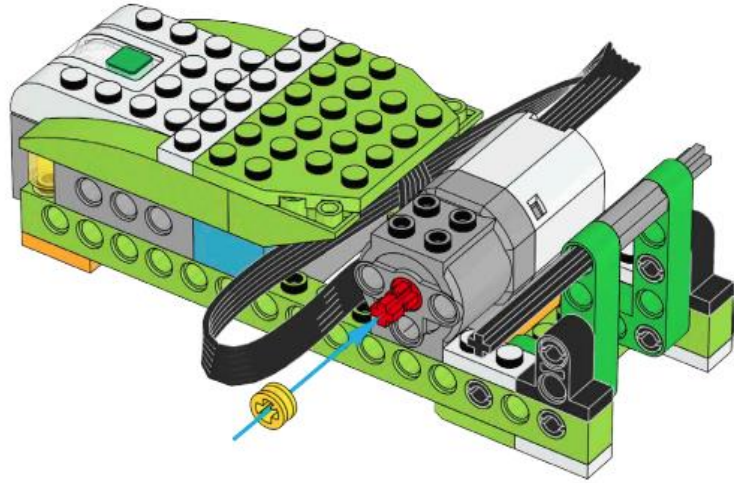

23

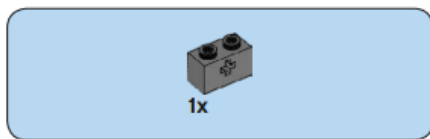
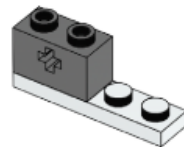

24

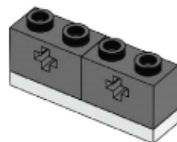

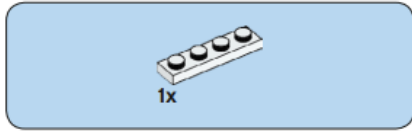

25

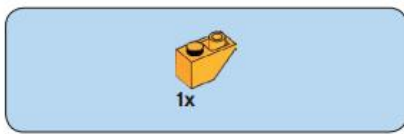
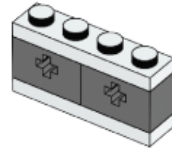

26

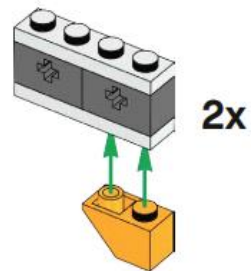

27

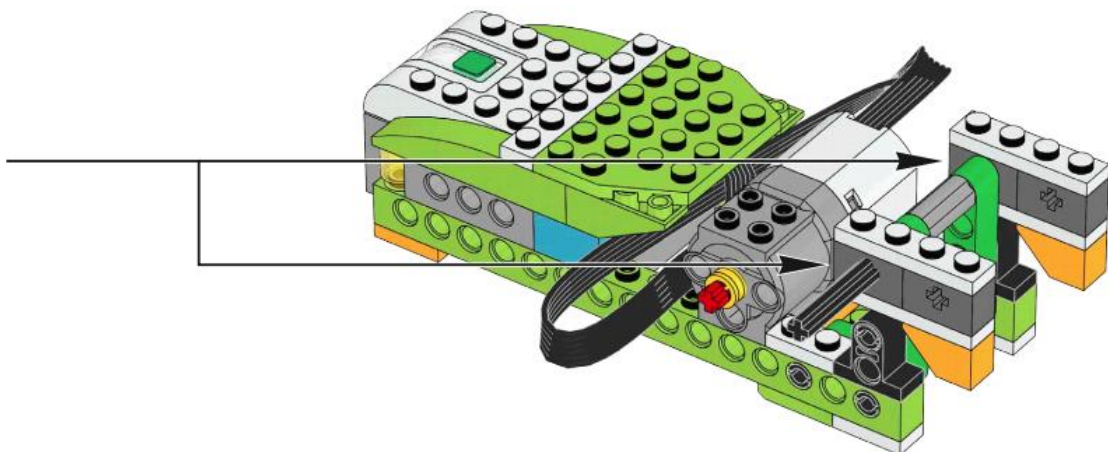

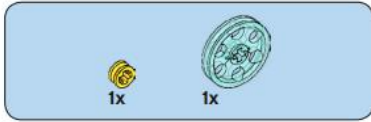

28

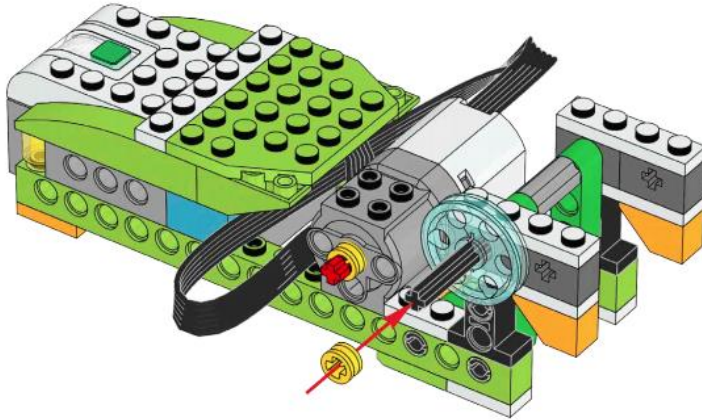

29

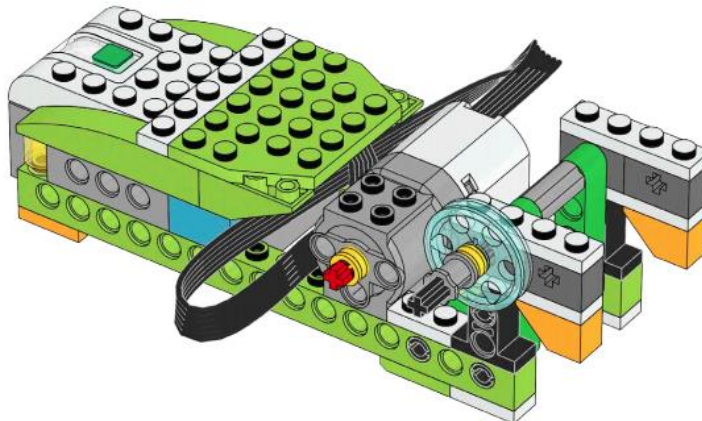

30

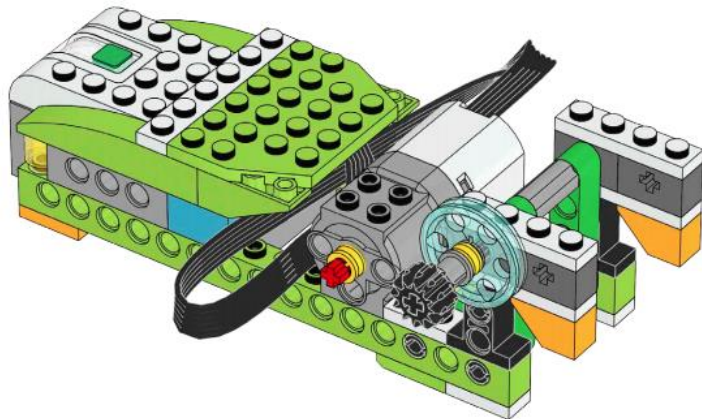

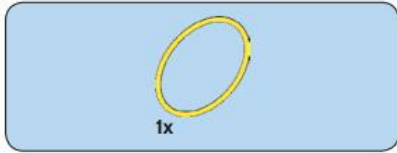

31

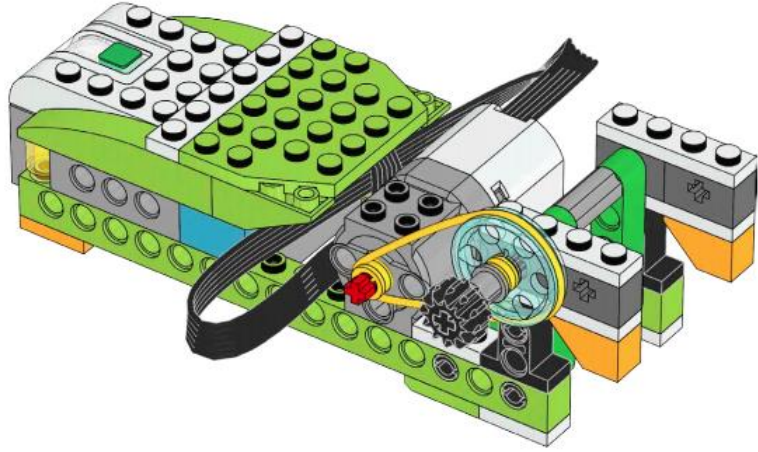

32

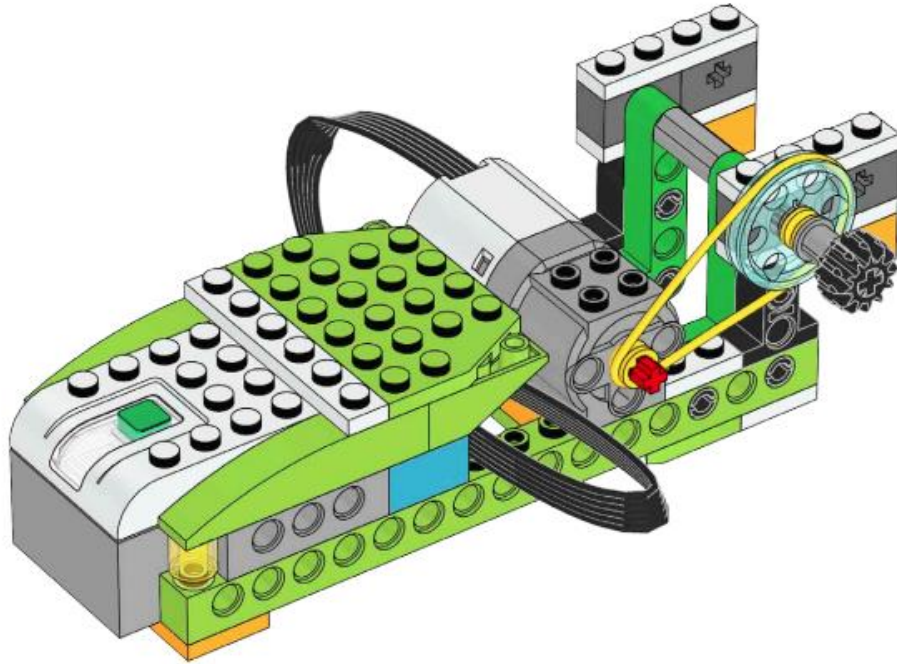

Codificación



Realiza los siguientes cambios:



Hemos creado una plataforma se sube y se baja.